

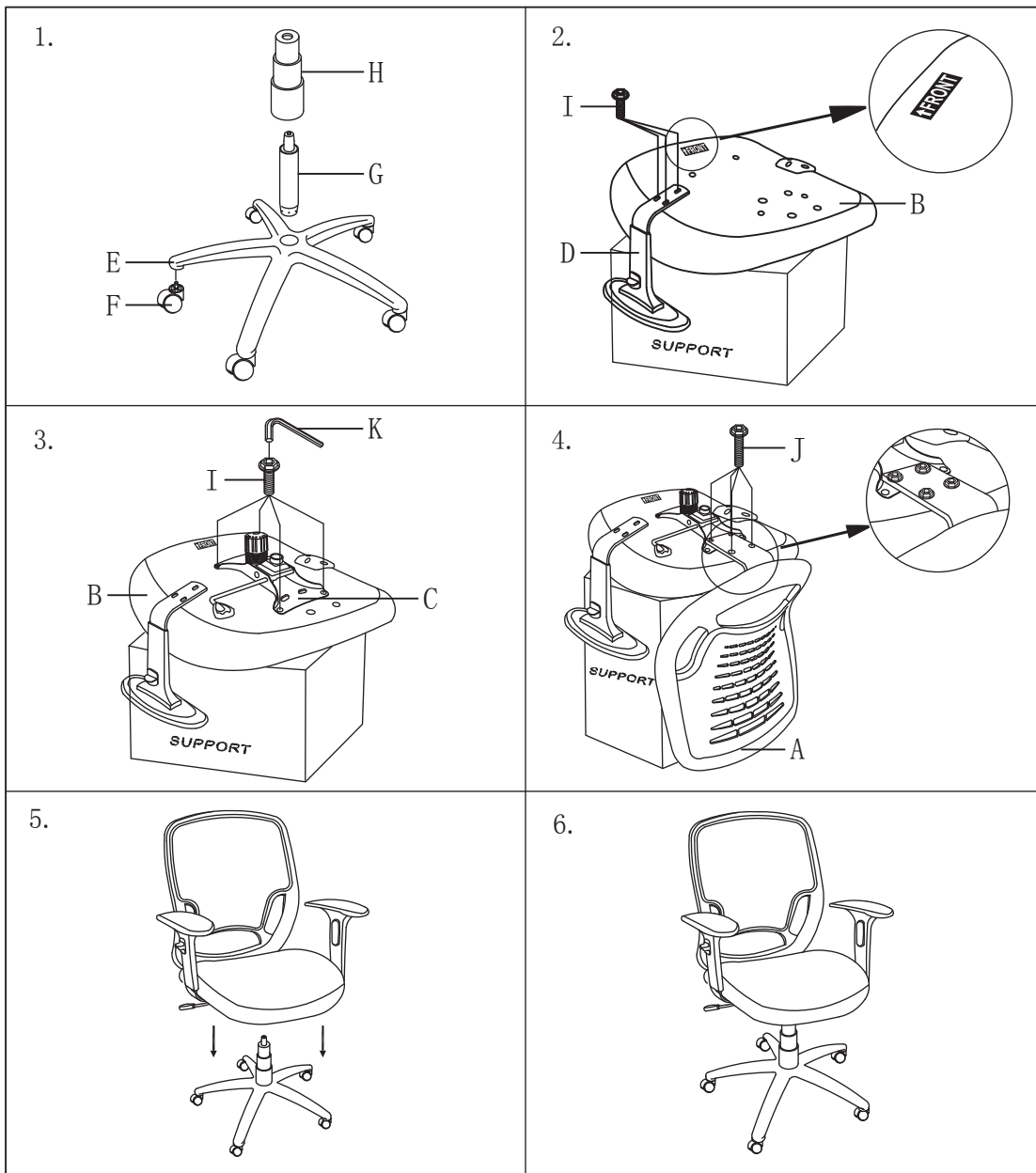







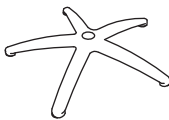

ASSEMBLY INSTRUCTIONS

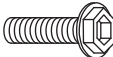
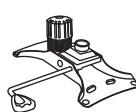

A.	E.	I.
		
1 PC	1 PC	10 PCS
B.	F.	J.
		
1 PC	5 PCS	4 PCS
C.	G.	K.
		
1 PC	1 PC	1 PC
D.	H.	
		
1 PAIR	1 PC	

Model: OIF-EM4817/EM4847
 1 Parkway North, Suite 100, Deerfield, IL 60015 ©2012 USSCo
 Made in/ Hecho en/ Fabriqué en China
 Product support and parts: 1-800-733-4000
 Ayuda del producto y partes / Support technique et pieces

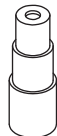
OPERATING INSTRUCTIONS

Model: OIF-EM4817/EM4847

Seat Height

To raise the seat height, stand up from the chair while lifting the lever, "A," under the right side of the seat. To lower the seat height, lift the lever, "A," while sitting in the chair.

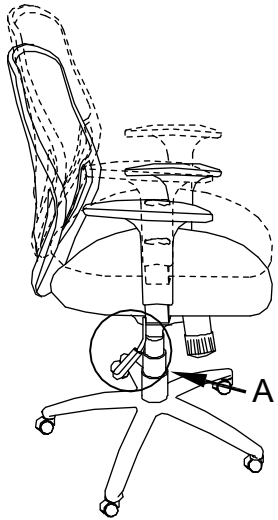

Tilt Lock

Pull lever, "A," on the right side of the seat away from the chair and lean back to recline. To lock chair in upright position, push lever back towards the chair.

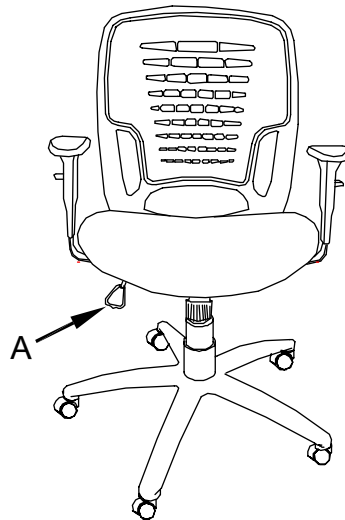

Tilt Tension

Knob underneath seat adjusts ease with which chair reclines to the different weights and strengths of different users. To increase tension turn knob to the right. To release tension (loosen), turn knob to the left.

